

List of Newly Released Technologies

◆ Electrified Technologies Batteries

▽ **Innovating Batteries - Supporting Toyota's Evolution to Next-Generation BEVs**

The battery is the heart of the battery EV (BEV). Just as the heart pumps blood through the body, the battery transfers electricity to the vehicle.

As Toyota advances its efforts toward introducing next-generation BEVs in 2026, **the company is also evolving batteries with new technologies to meet customer expectations.**

Liquid lithium-ion batteries, which are currently the mainstream, will gain enhanced performance by improving the energy density of square batteries, an area in which Toyota has long expertise. In addition, by adopting the bipolar structure that has been developed for HEVs to BEVs, **we will expand our lineup to provide customers with a variety of options**, from low-cost, popular batteries to batteries that pursue even higher performance.

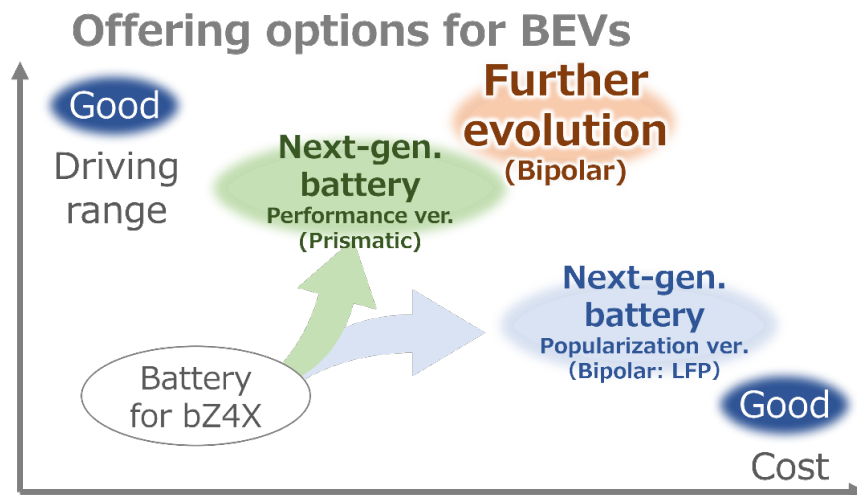

Furthermore, **all-solid-state batteries, which are highly anticipated as innovative batteries, are finally entering the practical application phase for use in BEVs.** Our full lineup of competitive batteries will support the evolution of Toyota's BEVs in the future.

*The performance version next-generation battery is being developed with Prime Planet Energy & Solutions Corporation, while the popularization and high-performance versions of the next-generation batteries and all-solid-state battery for BEVs are being developed with Toyota Industries Corporation, combining the knowledge of the Toyota Group.

1. Next-generation batteries: Performance version

- The next-generation BEV to be introduced in 2026 **will have a cruising range of 1,000 km** *1. We are developing a square battery with a focus on performance to install in such cars.
- While increasing the energy density of the battery, we aim to increase the cruising range by improving vehicle efficiencies, such as aerodynamics and weight reduction, while at

the same time **reducing costs by 20% compared to the current bZ4X and achieving a quick charge time of 20 minutes or less (SOC=10-80%).**



2. Next-generation batteries: Popularization version

- Toyota is also **developing good, low-cost batteries** that will contribute to the spread and expansion of BEVs to **provide customers with a variety of choices in batteries.**
- **The bipolar structure battery, which has been used in the Aqua and Crown hybrid vehicles, is now being applied to BEVs.** The battery uses inexpensive lithium iron phosphate (LFP) as a material and is expected to be put to practical use in 2026-2027.
- **We are aiming for a 20% increase in cruising range, a 40% reduction in cost, and quick recharging in 30 minutes or less (SOC=10-80%)** compared to the current bZ4X and considering installing it in BEVs in the popular price range.

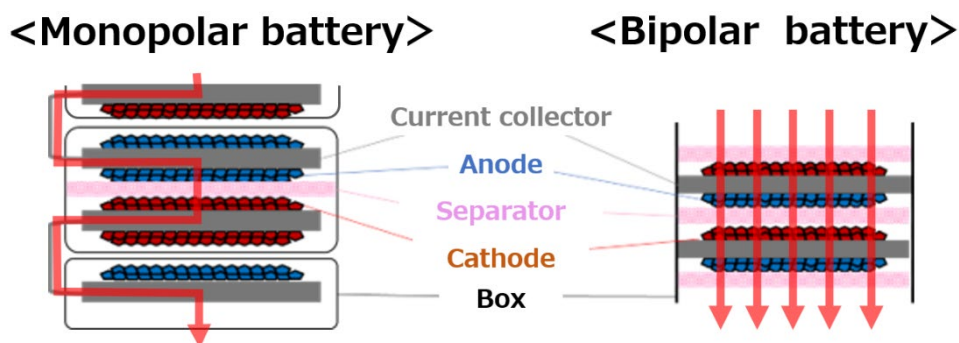

3. Bipolar lithium-ion battery: High-performance version

- In parallel with the development of the “popularization version” of the battery (2), a **high-performance battery that combines a bipolar structure with a high nickel cathode to achieve further advances** will be put to practical use in 2027-2028.
- It will achieve even greater performance than the “performance version” of the square battery (1), **with a 10% increase in cruising range, a 10% reduction in cost, and a quick charge time of 20 minutes or less (SOC=10-80%).**

Battery type		Shape	Structure	Positive electrode	Start of production	Driving range (CLTC mode, including vehicle improvements)	Cost (For the same driving range)	Fast Charge Time (SOC=10~80%)
Conventional	Battery for bZ4X	Prismatic	Monopolar	NCM series	2022	615 km	-	~30 min.
Next-gen. battery	1. Performance ver.	Prismatic	Monopolar	NCM series	2026	200% Comparing with bZ4X	▲20% Comparing with bZ4X	~20 min.
	2. Popularization ver.	New structure	Bipolar	LFP series	2026-27 Challenge to launch	20% UP Comparing with bZ4X	▲40% Comparing with bZ4X	~30 min.
Further evolution	3. Fusion of performance & bipolar	New structure	Bipolar	Ni series	2027-28 Challenge to launch	10% UP Comparing with next-gen. battery performance ver.	▲10% Comparing with next-gen. battery performance ver.	~20 min.

4. All-solid-state batteries for BEVs

- **Having discovered a technological breakthrough that overcomes the longstanding challenge of battery durability**, the company is reviewing its introduction to conventional HEVs and **accelerating development as a battery for BEVs, for which expectations are rising.**
- We are currently developing a method for mass production, striving for commercialization in 2027-2028.
- **We are looking at a 20% improvement in cruising range*1** compared to the performance version of the square battery shown in 1., while costs are under scrutiny, **aiming for a quick charge time of 10 minutes or less (SOC=10-80%).**

Also, **with an eye to the future, a higher-level specification is under research and development at the same time. This one aims for a 50% improvement in the cruising range compared to 1.**

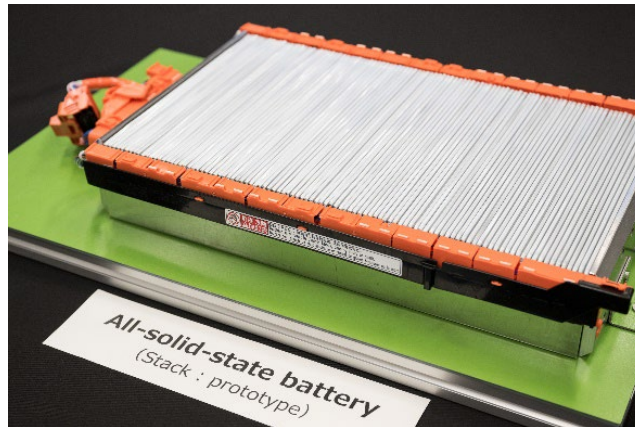

*1 Including vehicle efficiency improvements such as aerodynamics and weight reduction

Aerodynamics

▽ **New technology that can reduce aerodynamic drag in any shape, enhancing the product appeal of BEVs.**

We are studying the application of hypersonic technology used in rockets to BEVs and are collaborating with Mitsubishi Heavy Industries on **a new technology to reduce aerodynamic drag in any shape.**

In addition to battery innovation, **we will take on the challenge of further extending the cruising range by minimizing aerodynamic drag** and will continue to improve our BEV products to **exceed our customers' expectations.**

■ **Aerodynamic technology based on rocket hypersonic technology**

- **New aerodynamic drag reduction technology based on rocket hypersonic aerodynamics**
- We are currently studying the technology in cooperation with the Space Systems Division of Mitsubishi Heavy Industries, Ltd.
- We are aiming to introduce the findings into next-generation BEVs as fundamental technologies.
- By being able to **reduce aerodynamic drag without being restricted by the shape of the car**, it is expected to combine an attractive design/packaging with aerodynamic performance (Cd0.1 level in view).
- The development of new technologies is underway in different speed ranges by applying the knowledge of boundary layer control in the ultra-high-speed range obtained from aerospace technology.



Production process 1/2

▽ Changing the manufacturing situation

To ensure the profitability of BEVs, we will work on both vehicle technology and manufacturing.

First, the vehicle body will be made **simple and slim in structure and molded through giga casting, for significant parts integration.**

Also, we will create highly flexible production plants without conveyors by introducing concepts like a self-propelling assembly line.

In designing the BEV production plant, we will employ digital technology to increase the accuracy of process verification. Through these efforts, we aim to **reduce the production preparation lead time, production processes, and factory investment for mass-produced vehicles to 1/2, and achieve a significant reduction in fixed costs.**

1. Giga casting

- This process achieves high productivity integrated molding of what a carmaker considers to be the optimum shape.
- We are also developing technology for integrated molding with aluminum die-casting of what used to be made with dozens of sheet metal parts.
- After analyzing the casting technology that has been cultivated in the car manufacturing *genba* to a high degree of precision, we have reviewed the **structural design to make it simpler and slimmer.**
- In addition to reducing the number of parts and processes, it also reflects the **TPS philosophy of eliminating waste in each process.**



2. Self-propelling assembly line

- We will take on the challenge to design a next-generation production plant that eliminates the concept of a "conveyor."

- The technology is being developed to enable mass-produced cars under assembly to move to the next process on their own.
- Sensors and control systems on the factory side communicate with wireless terminals mounted on the mass-produced vehicles to control them from the outside. We will aim to **integrate the car and the production plant**.
- The elimination of conveyors will make the factory layouts more flexible and significantly reduce factory investment and the **lead time as well as human resources required to prepare for mass production**, which used to take years.

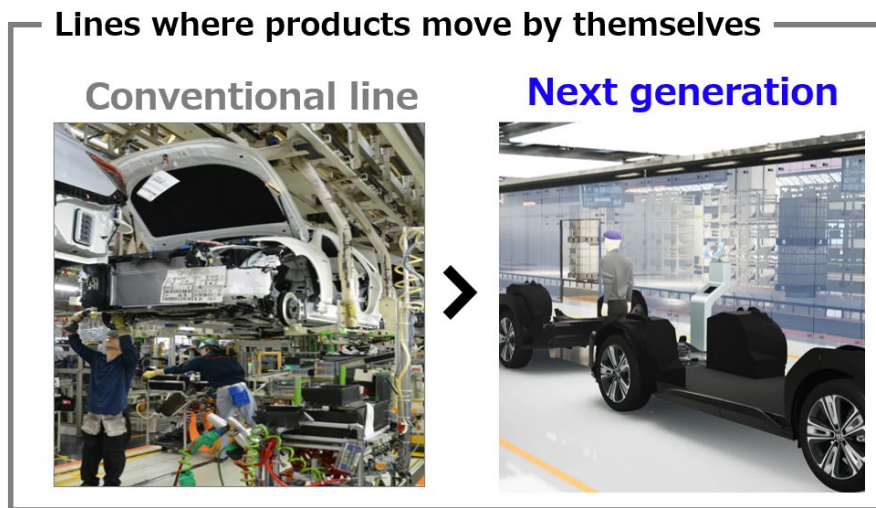

3. Next Generation production plant design

- **Digital technology will be examined** for manufacturing in the next-generation BEV plant.
- Technologies such as giga casting and self-driving assembly lines are compatible with digitalization, and **digital technology will be actively employed in the plant design, including process study and improvement.**
- **We will shorten mass production preparation lead time through reproduction accuracy at the 1 mm error level.**
- We will shift to more efficient production lines with unmanned transport using connected technology, autonomous inspections, etc., and **take on the challenge to drastically change the manufacturing situation by adopting TPS concepts, etc.**

Technology that works well with digital



- No need for parts matching
- High-precision body by machining

- No equipment required
- Simply assembled from bottom to top



Self-propelled assembly line

Study of manufacturing digitally

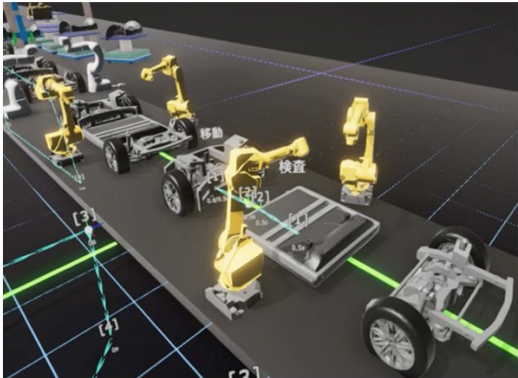

➤

Fundamental technologies to improve BEV product appeal

- ▽ **We will use the fundamental technologies of manufacturing that we have cultivated to date to improve the product appeal of BEVs.**

We are further developing fundamental technologies by making the most of those we have cultivated through manufacturing.

The Toyota Group as a whole will take advantage of the small eAxle and next-generation semiconductor technologies to improve the commercial potential of BEVs under development.

1. Small eAxle

- In order to downsize the eAxle's key components such as the motor, gear train, and inverter, we are developing small eAxle by **fully utilizing BluE Nexus, Aisin, Denso, and Toyota's in-house technologies cultivated through the development of HEVs.**
- By downsizing the eAxle, we realized **longer cruising range.**
It also enlarges the cargo space and reduces aerodynamic drag, which contribute to better comfort and design.

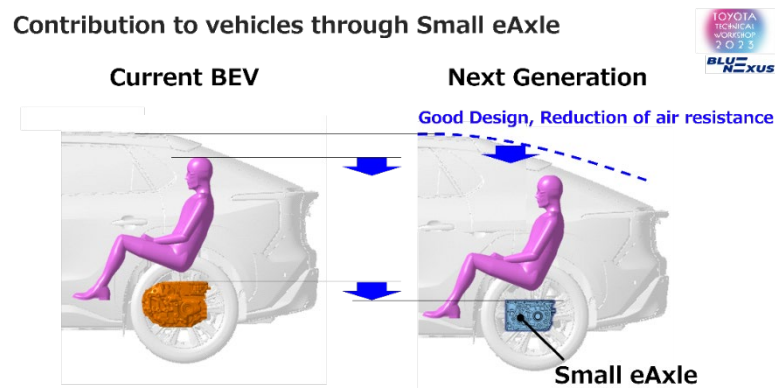

2. SiC wafers for BEV inverters (next-generation semiconductors with 50% less power loss)

- Technology for supporting next-generation BEVs
- Developing next-generation semiconductor materials from crystal growth that will contribute to improving the energy consumption of BEVs
- In addition to the gas method, which has the advantage of a crystal growth speed that is 10 times faster than the industry standard, we are also developing the industry's largest 8-inch wafer, which will promote the internalization of technology within the Toyota Group.

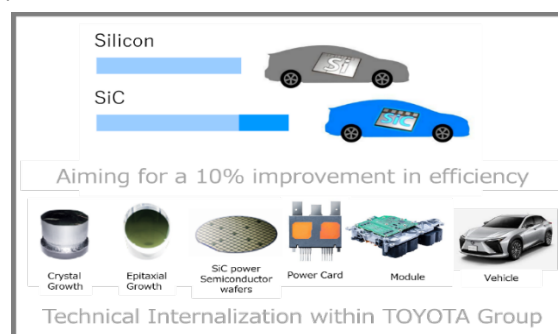

*The image is based on excerpts from the DENSO CORPORATION website.

Multi-pathway platform

▽ **Expanding our lineup with a platform that enables us to offer a variety of electrified vehicles.**

We have the technological capability to provide BEV models immediately through a **multi-pathway platform that enables us to offer a variety of electrified vehicles.**

We will expand our product lineup even before the introduction of the next-generation BEVs, with a set standard of 1.5 million units in 2026.

■ Multi-pathway platform

- We will develop a platform that enables us to offer a variety of electrified vehicles.
- **As an example of our technological capability to provide not only the bZ series but also Fun to Drive BEVs to meet the diverse needs of our customers, we have converted the powertrain of the Crown into a BEV.**

